

UTF™ Reduced Stem

Femoral Hip System



Surgical Technique Guide

Table of Contents

Device Description	II
Surgical Overview	IV
Surgical Protocol	
Pre-operative Planning and Templating	1
A. Femoral Osteotomy	2
B. Femoral Canal Accessing	3
C. Canal Reaming	4
D. Lateralization	5
E. Canal Broaching	6
F. Trial Reduction.....	7
G. Stem Insertion	8
H. Stem Impaction.....	9
I. Femoral Head Impaction.....	10
Order Information	11

Device Description

UTF (United Tapered Fit) Reduced Stem –

The dual taper wedge stem is designed for primary hip replacement surgery. The UTF reduced stem characterizes refined proximal M/L width to maximize metaphyseal fitting. A slim body and broach-only technique enables minimal bone removal.

Provides surgeons with a variety of fits for individual anatomies:

- 16 available sizes
- Standard and high offset options
- Up to 12 head neck length selections

INDICATIONS

This device is indicated for use in total hip replacement or bipolar hip replacement undergoing primary and revision surgery for the following conditions:

1. Non-inflammatory degenerative joint disease such as osteoarthritis, avascular necrosis, ankylosis, protrusion acetabuli, and painful hip dysplasia.
2. Inflammatory degenerative joint disease such as rheumatoid arthritis.
3. Correction of functional deformity.
4. Treatment of non-union, femoral neck fracture and trochanteric fractures of the proximal femur with head involvement, unmanageable using other techniques.
5. Revision procedures where other treatments or devices have failed.
6. This device is designed for cementless use.

Please refer to the package inserts for important product information, including, but not limited to contraindications, warnings, precautions, and adverse effects.



Surgical Overview

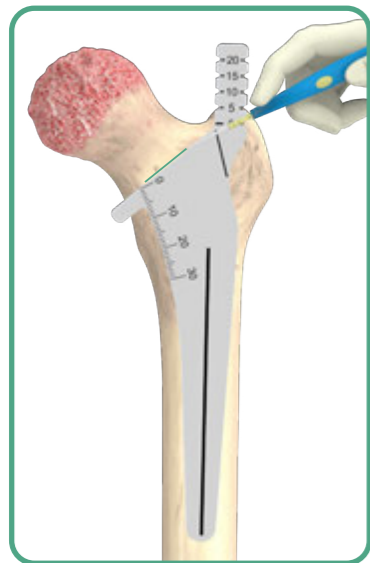

A. Femoral Osteotomy

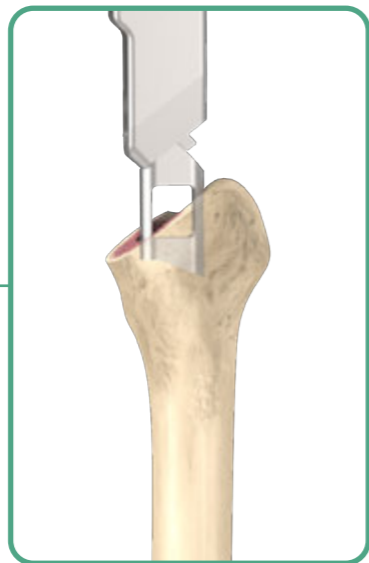

B. Femoral Canal Accessing



C. Canal Reaming



D. Lateralization

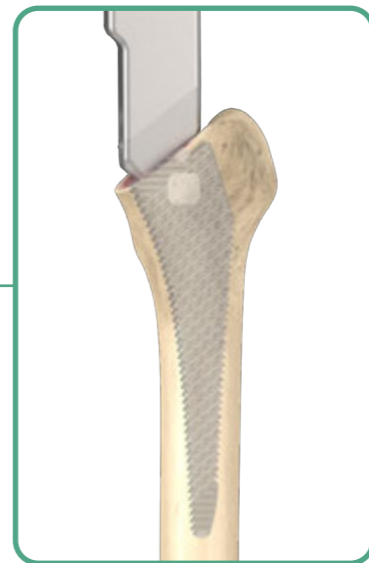

E. Canal Broaching

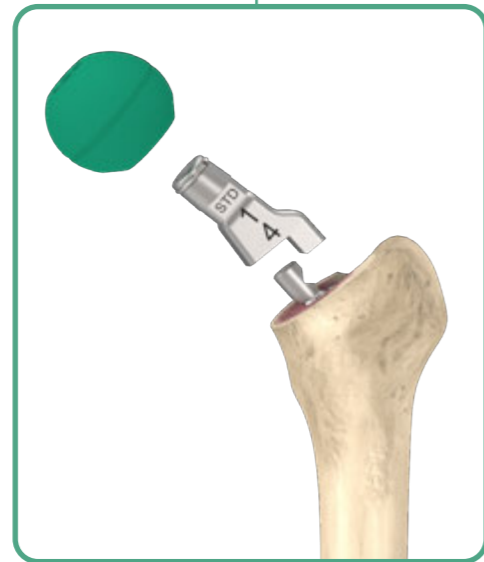

F. Trial Reduction

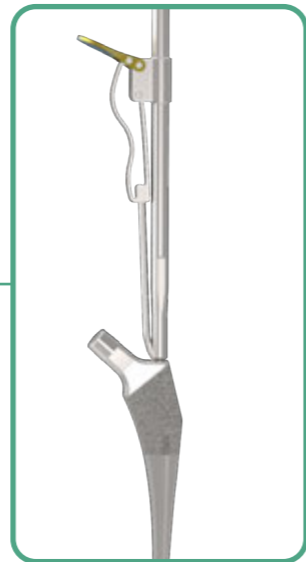

G. Stem Insertion



H. Stem Impaction

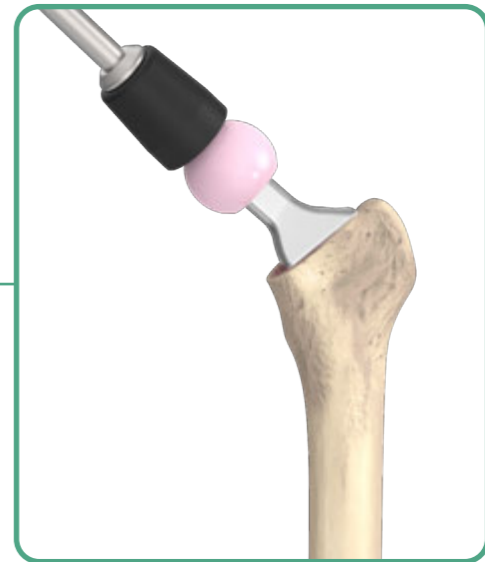

I. Femoral Head Impaction

Preoperative Planning and Templating

Preoperative planning is essential for determining the optimal stem size, neck resection level and the appropriate neck length. Making an accurate femoral component selection begins with thorough radiographic evaluation of the affected femur, both the A/P view and lateral view. The A/P radiographic image should include bilateral hip joints to help evaluate the affected side. These radiographs provide an estimation of leg length discrepancy, femoral offset and center of rotation needed to reconstruct hip biomechanics.

The UTF Reduced stem is designed to provide immediate geometrical stability through contact with the medial and lateral cortex. Standard and high offset options are available. It is recommended to pre-operatively template the prosthesis size that best fits the metaphysis canal area. Templates show the neck length and offset for each of the head/neck combinations (-3 to +10 mm, depending on head material and diameter).

The final determination of implant choice should take into account the acetabular cup position, cup size, and hip center.

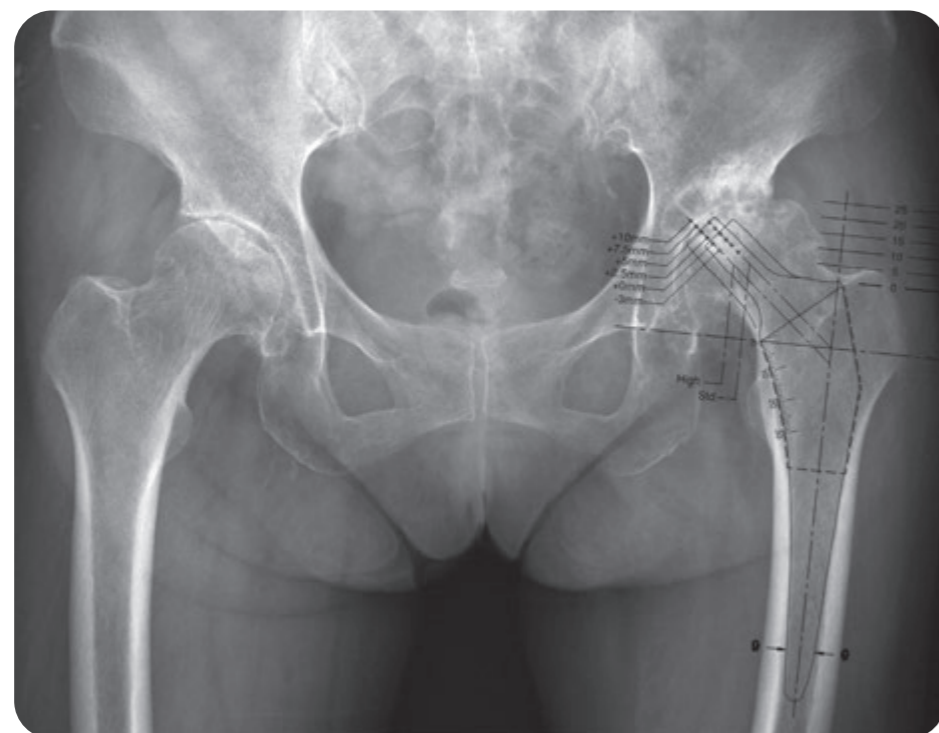

A. Femoral Osteotomy

During preoperative templating, determine the neck resection level by referencing the distance above the lesser trochanter (about 10~15 mm)

Intra-operatively, align the **Neck Resection Guide** with the anatomical axis of the femoral canal. Mark the cut line using electrocautery, then complete the femoral neck resection with a power saw. Connect the **Femoral Head Extractor** with **Modular T-Handle** or power tool then remove the femoral head.

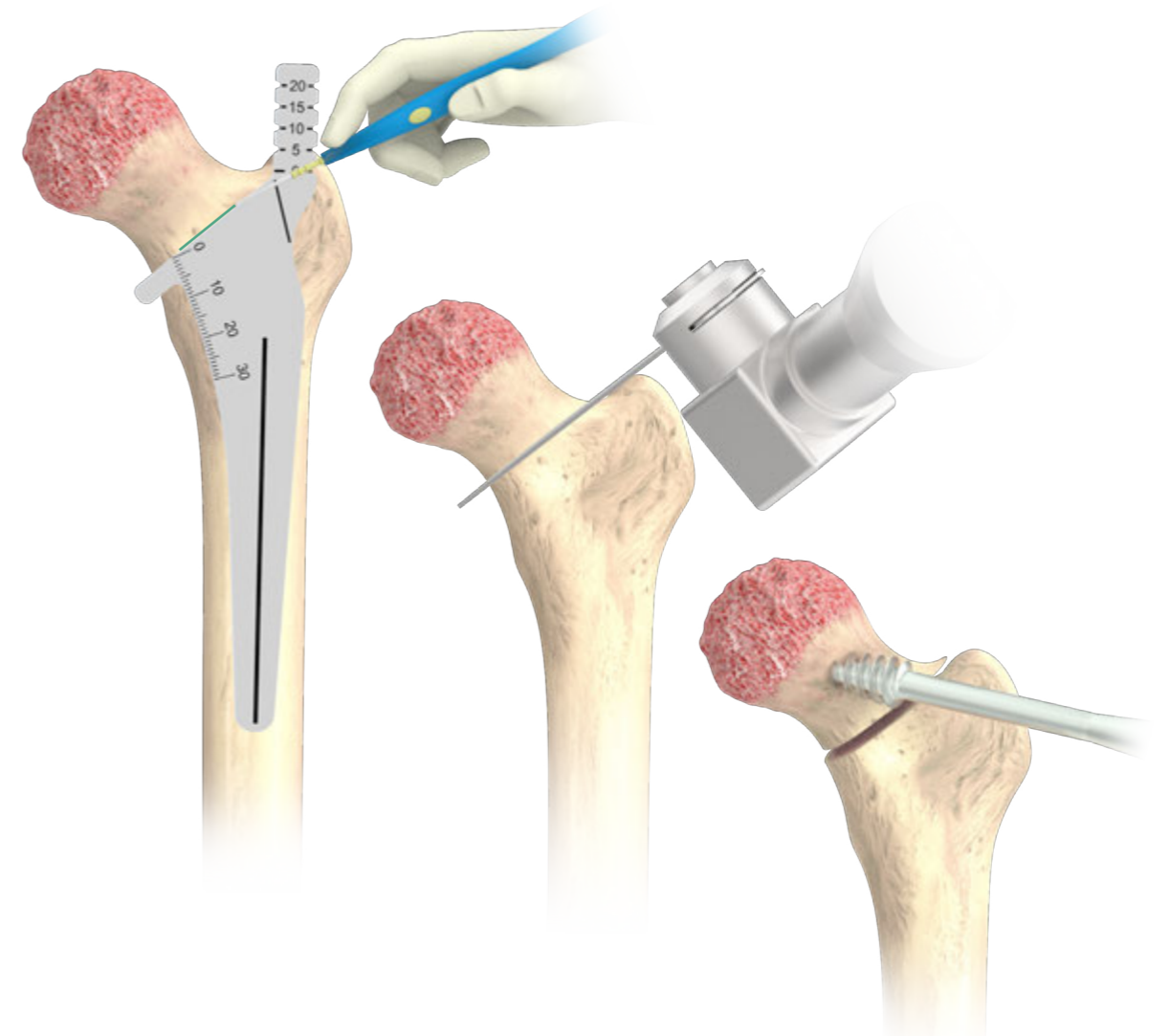

Instruments



Neck Resection Guide



Modular T-Handle



Femoral Head Extractor

B. Femoral Canal Accessing

Utilize the modular **Femoral Cutting Chisel** with **Broach Handle** for adequate lateral/posterior piriformis fossa initial entry into femoral canal.



Instruments



Femoral Cutting Chisel Straight Broach Handle Offset Broach Handle Dual Offset Broach Handle

C. Canal Reaming

The **Starter Reamer** is used with the **Modular T-Handle** to open the femoral canal and to help ensure the correct reamer alignment within the femoral anatomical axis.

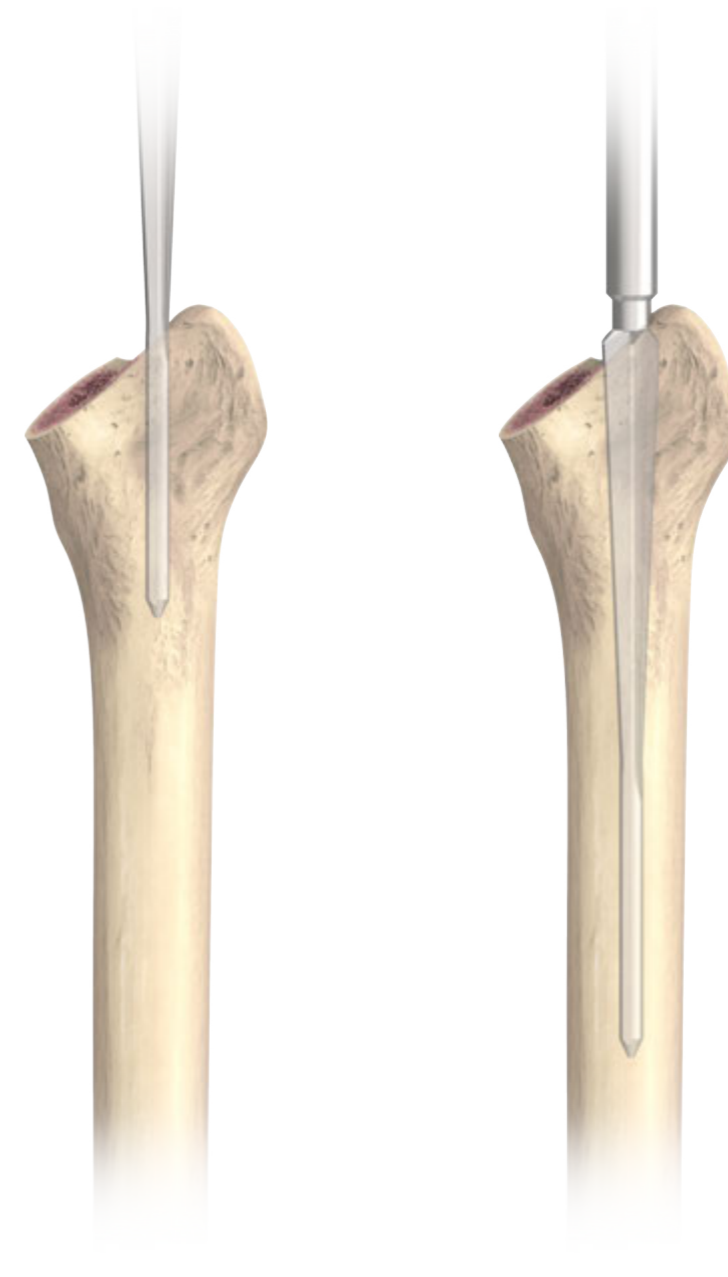

Instruments

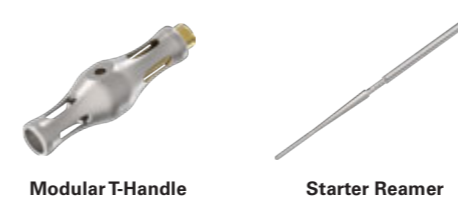

Modular T-Handle Starter Reamer

D. Lateralization

Appropriate lateralization of the canal entry when needed is important to prevent medial shift alignment of the prosthetic stem during insertion. Utilize the **Canal Finder Rasp** manually to enlarge the canal laterally beneath the greater trochanter. This step helps to guide the axis of the femur for subsequent broaching and stem implantation.



Instruments



Canal Finder Rasp

E. Canal Broaching

Multiple broach handle options are provided to accommodate different surgical approaches for hip replacement.

A **Starter Broach** can be utilized to provide an initial reference for the direction of subsequent femoral broaching.

Attach the smallest **UTF Broach, Reduced** to the proper **Broach handle**. Start broaching along the axis of the femur maintaining the appropriate orientation of the broach until the cutting edge is fully seated under the resection line.

Gradually enlarge the broach size until the planned template size is achieved. Confirm the axial and rotational stability of the final broach.

Two types of broaches are provided:

- **UTF Broach, Reduced (Gold)** - the interference between implant and broach is 0.5 mm per side.
- **UTF Broach, Reduced, ML 0 mm (Silver)** - the ML dimension of the broach is identical to the implant.

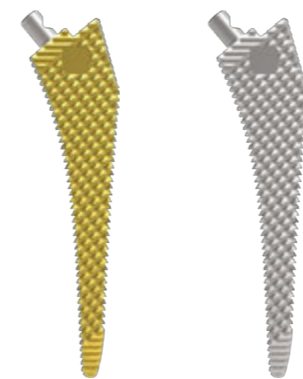
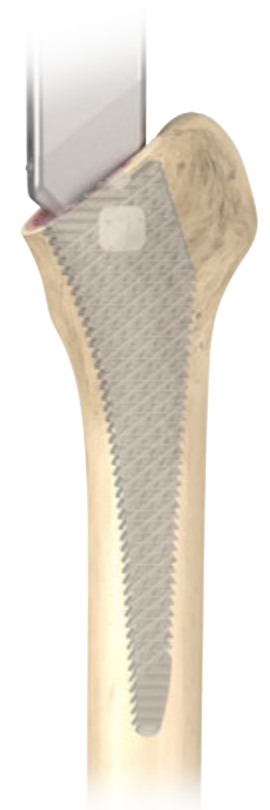

Gold

Silver

Note:

The insertion depth of #0 & #00 and #1~#14 broach is different.



Insertion Depth

#0 & #00

Insertion Depth

#1 ~ #14

Instruments



Straight Broach Handle

Offset Broach Handle

Dual Offset Broach Handle

Start Broach

UTF Broach, Reduced

UTF Broach, Reduced ML 0 mm

F. Trial Reduction

Assemble the corresponding size standard or high offset **UTF Neck Trial** onto the broach. Perform the trial reduction using the **Femoral Head Trial** with the desired diameter and neck length.



Broach Size	Neck Trial	
	STD	HO
	#0 - #00*	#0
	#1 - #4	
	#5 - #8	
	#9 - #12	
	#13 - #14	

*#0-00 only for UTF Standard Neck Trial

Instruments

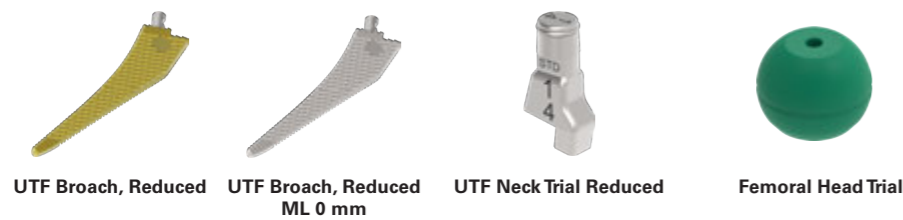

G. Stem Insertion

After trial reduction, remove the broach and introduce the stem by using the **Quick Connect Holder**. Use the holder to firmly attach the stem via the insertion hole on the stem shoulder.

Gently tap the holder to achieve initial stem implantation into the medullary canal.

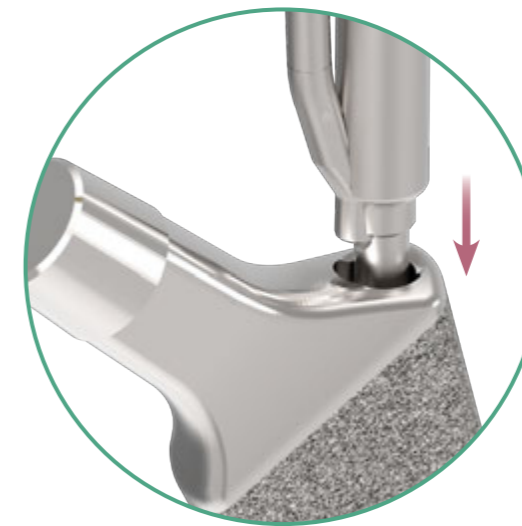

Caution: The **Quick Connect Holder** is designed to position the implant, not for final impaction. Please **impact gently**.

Instruments



Quick Connect Holder

H. Stem Impaction

Use **Straight** or **Curved Stem Impactors** to further advance the stem into the canal. The prosthesis should be seated until the most proximal portion of the coating surface is in line with the neck resection level.

Note:

Proper care should be taken to orient the stem with proper alignment and version during implant impaction.

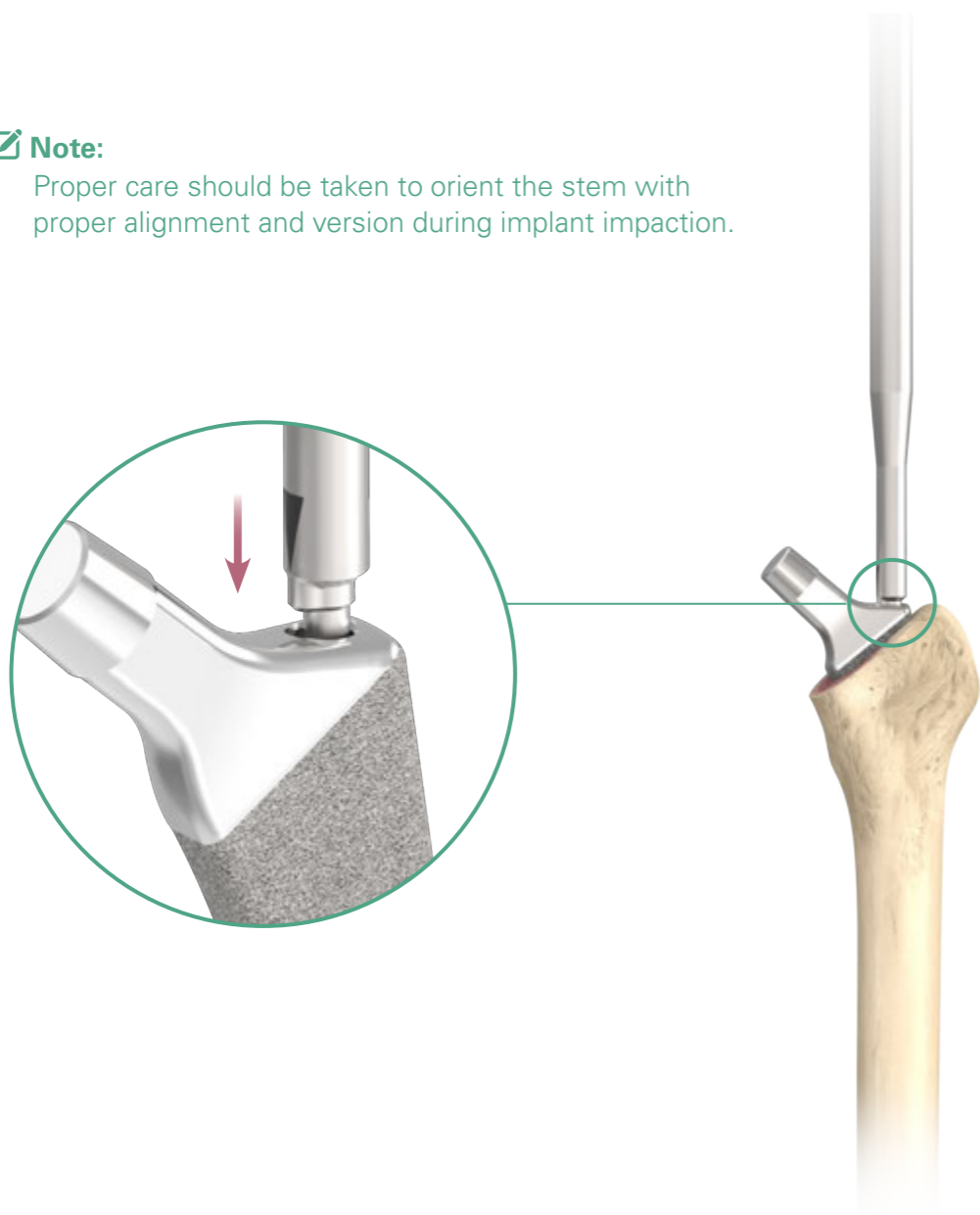

Instruments



Straight Stem Impactor



Curved Stem Impactor

I. Femoral Head Impaction

Perform a final trial reduction to confirm stability and leg length by using the **Femoral Head Trials**. After the appropriate femoral head size has been determined, place it onto the cleaned and dried trunnion by hand.

Connect the **Femoral Head Impactor** and **Universal Handle** and moderately impact the femoral head until it is firmly seated.



Instruments



Femoral Head Trial



Femoral Head Impactor



Universal Handle

Order Information

Standard



Catalog Number	Description
----------------	-------------

1106 - 3099	# 00
1106 - 3000	# 0
1106 - 3001	# 1
1106 - 3002	# 2
1106 - 3003	# 3
1106 - 3004	# 4
1106 - 3005	# 5
1106 - 3006	# 6
1106 - 3007	# 7
1106 - 3008	# 8
1106 - 3009	# 9
1106 - 3010	# 10
1106 - 3011	# 11
1106 - 3012	# 12
1106 - 3013	# 13
1106 - 3014	# 14

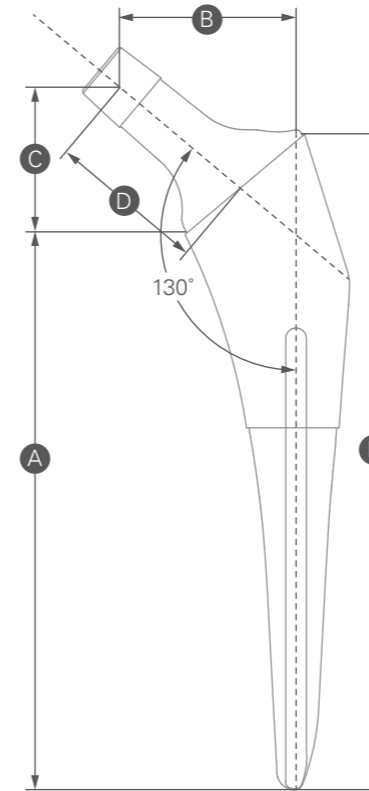

Size	A Medial Length	B Offset	C Vertical Height	D Neck Length	E Lateral Length
Standard					
#00	95	32	25.9	28	114
#0	100	32	26.2	28	120
#1	105	32	26.5	28	125
#2	107	33	27.6	29	128
#3	110	34	28.4	30	131
#4	113	35	29.3	31	134
#5	116	36	30.1	32	137
#6	118	37	31.0	33	140
#7	120	38	31.8	34	142
#8	122	39	32.6	35	144
#9	123	39	32.7	35	146
#10	126	41	34.3	37	149
#11	128	42	35.1	38	152
#12	131	43	36.0	39	155
#13	133	44	36.7	39.5	158
#14	135	45	37.2	40	161
High Offset					
#0	100	38	26.3	32	120
#1	105	38	26.6	32	125
#2	107	39	27.6	33	128
#3	110	40	28.5	34	131
#4	113	41	29.3	35	134
#5	116	43	30.1	37	137
#6	118	44	31.0	38	140
#7	120	45	31.8	39	142
#8	122	46	32.6	40	144
#9	123	47	32.7	40	146
#10	126	49	34.3	42	149
#11	128	50	35.1	43	152
#12	131	51	36.0	44	155
#13	133	52	36.7	45	158
#14	135	53	37.2	45.5	161

High Offset



Catalog Number	Description
----------------	-------------

1106 - 3200	# 0
1106 - 3201	# 1
1106 - 3202	# 2
1106 - 3203	# 3
1106 - 3204	# 4
1106 - 3205	# 5
1106 - 3206	# 6
1106 - 3207	# 7
1106 - 3208	# 8
1106 - 3209	# 9
1106 - 3210	# 10
1106 - 3211	# 11
1106 - 3212	# 12
1106 - 3213	# 13
1106 - 3214	# 14

Femoral Head

	Catalog Number	Description (mm)
<p>U2 Femoral Head</p> 	1206 - 1122	* Ø 22 + 0
	1206 - 1322	* Ø 22 + 3
	1206 - 1522	* Ø 22 + 6
	1206 - 1722	* Ø 22 + 9
	1206 - 1026	Ø 26 - 2
	1206 - 1126	Ø 26 + 0
	1206 - 1326	Ø 26 + 3
	1206 - 1526	Ø 26 + 6
	1206 - 1726	Ø 26 + 9
	1206 - 1028	Ø 28 - 3
	1206 - 1128	Ø 28 + 0
	1206 - 1228	Ø 28 + 2.5
	1206 - 1428	Ø 28 + 5
	1206 - 1628	Ø 28 + 7.5
	1206 - 1828	Ø 28 + 10
	1206 - 1032	Ø 32 - 3
	1206 - 1132	Ø 32 + 0
	1206 - 1232	Ø 32 + 2.5
	1206 - 1432	Ø 32 + 5
	1206 - 1632	Ø 32 + 7.5
	1206 - 1832	Ø 32 + 10
	1206 - 1036	Ø 36 - 3
	1206 - 1136	Ø 36 + 0
	1206 - 1236	Ø 36 + 2.5
	1206 - 1436	Ø 36 + 5
	1206 - 1636	Ø 36 + 7.5
	1206 - 1836	Ø 36 + 10

* The actual spherical diameter of a 22 mm head is 22.2 mm.

Femoral Head

	Catalog Number	Description (mm)
<p>BIOLOX® delta Ceramic Head</p> 	1203 - 5022	*Ø 22 S + 1
	1203 - 5222	*Ø 22 M + 3
	1203 - 5422	*Ø 22 L + 5
	1203 - 5028	Ø 28 S - 2.5
	1203 - 5228	Ø 28 M + 1
	1203 - 5428	Ø 28 L + 4
	1203 - 5032	Ø 32 S - 3
	1203 - 5232	Ø 32 M + 1
	1203 - 5432	Ø 32 L + 5
	1203 - 5632	Ø 32 XL + 8
	1203 - 5036	Ø 36 S - 3
	1203 - 5236	Ø 36 M + 1
	1203 - 5436	Ø 36 L + 5
	1203 - 5636	Ø 36 XL + 9
	1203 - 5040	Ø 40 S - 3
	1203 - 5240	Ø 40 M + 1
1203 - 5440	Ø 40 L + 5	
1203 - 5640	Ø 40 XL + 9	

* The actual spherical diameter of a 22 mm head is 22.2 mm.

BIOLOX® is a registered trademark of the CeramTec Group, Germany

Please note that this Surgical Technique Guide has been authored in the English language. Any translations into other languages have not been reviewed or approved by United Orthopedic Corporation and their accuracy cannot be confirmed. Any translated guide should be reviewed carefully prior to use and questions regarding a Surgical Technique Guide should be directed to United Orthopedic Corporation at [unitedorthopedic.com/contact](https://www.unitedorthopedic.com/contact)

The CE mark is valid only if it is also printed on the product label.

